

# Poniprintsessi piparkoogiloss



# Vaatetorn (x2)



1.

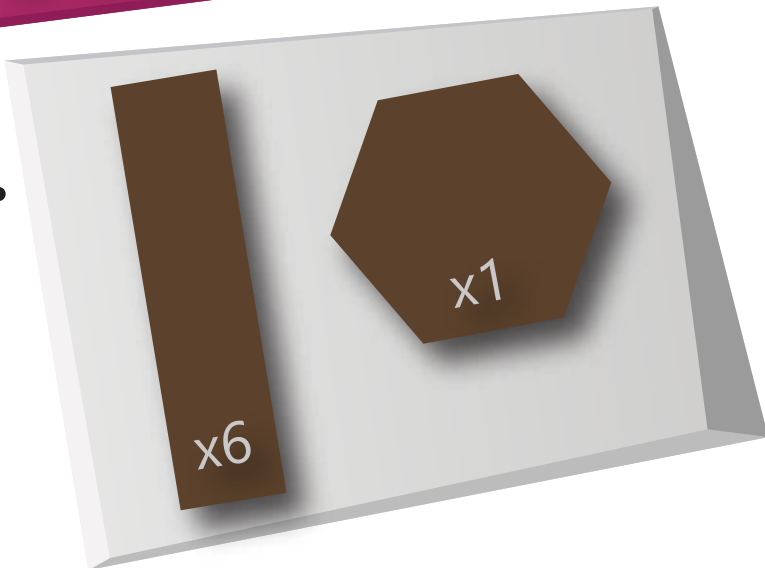

2.

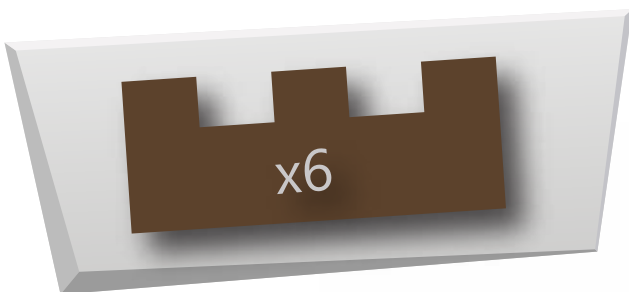

...ja nüüd tee  
teine samasugune  
veel

# Kesktorn



1.

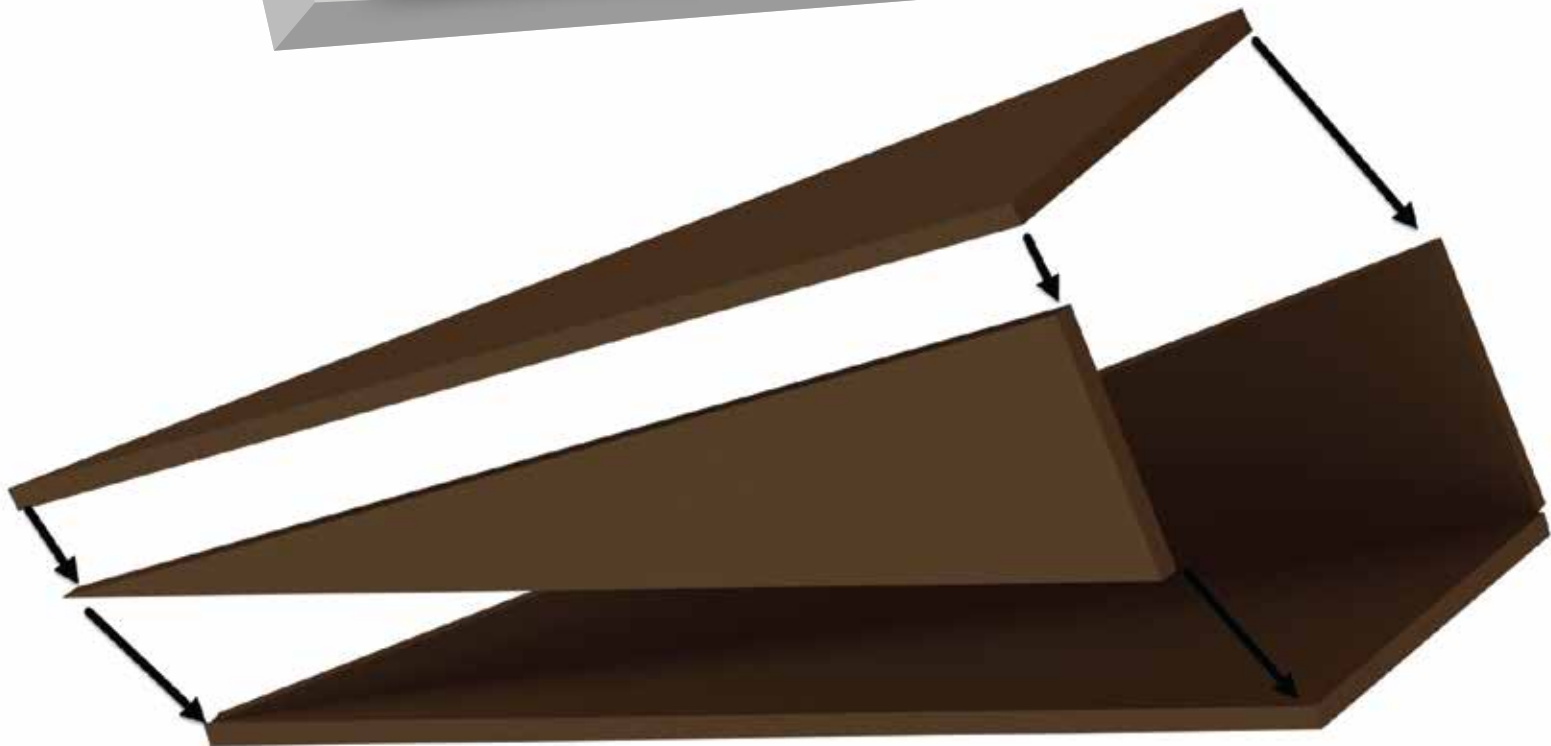

# Poniprintsessi loss

1.

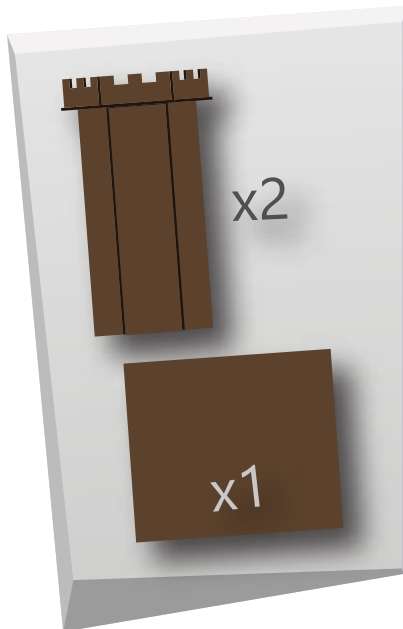

2.

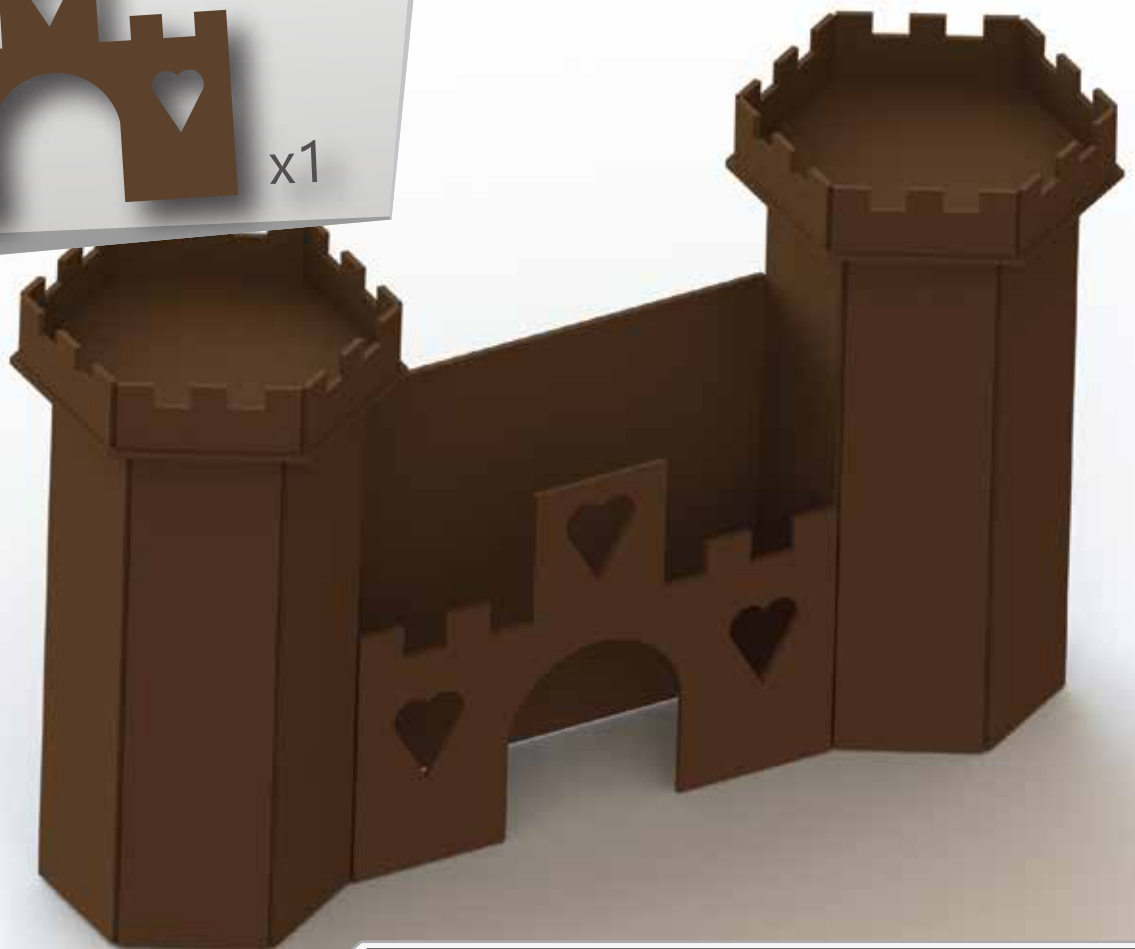

3.

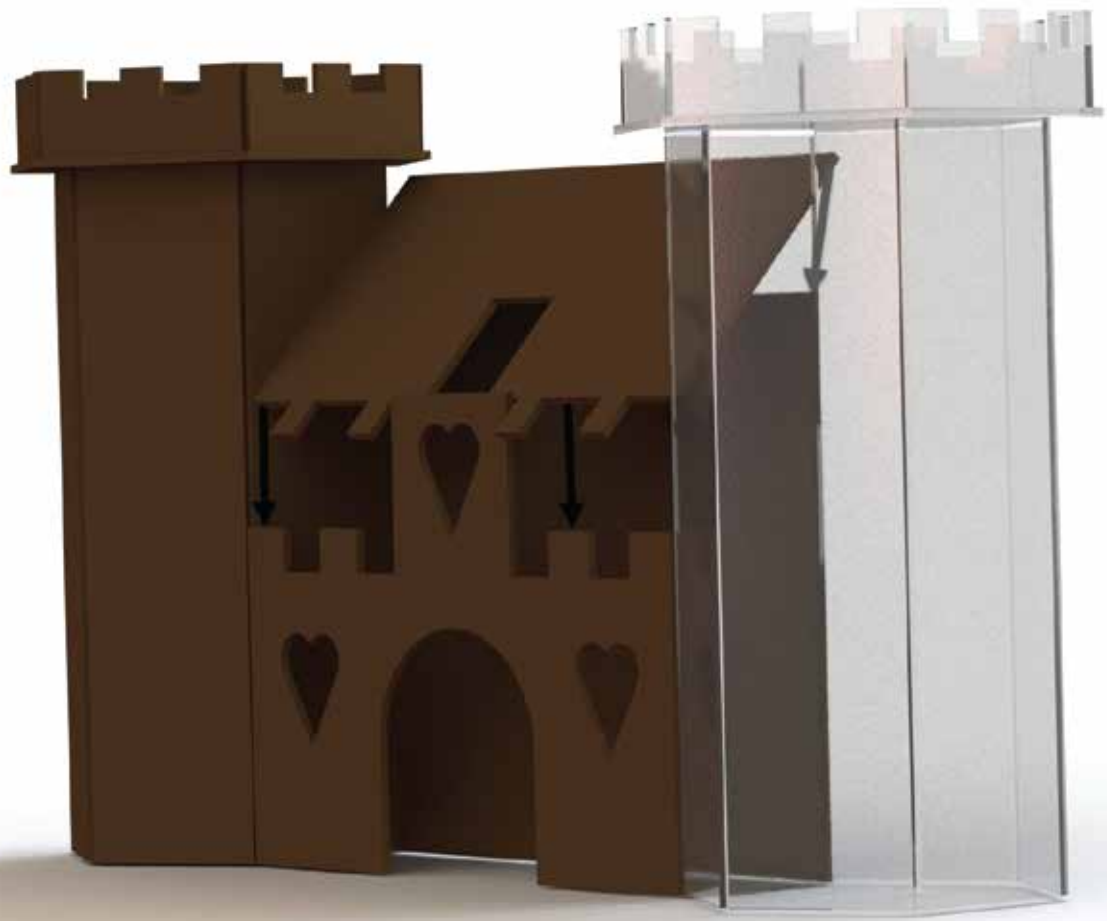
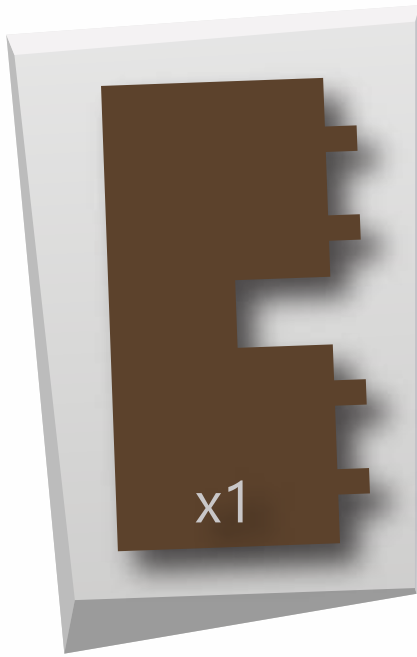

4.

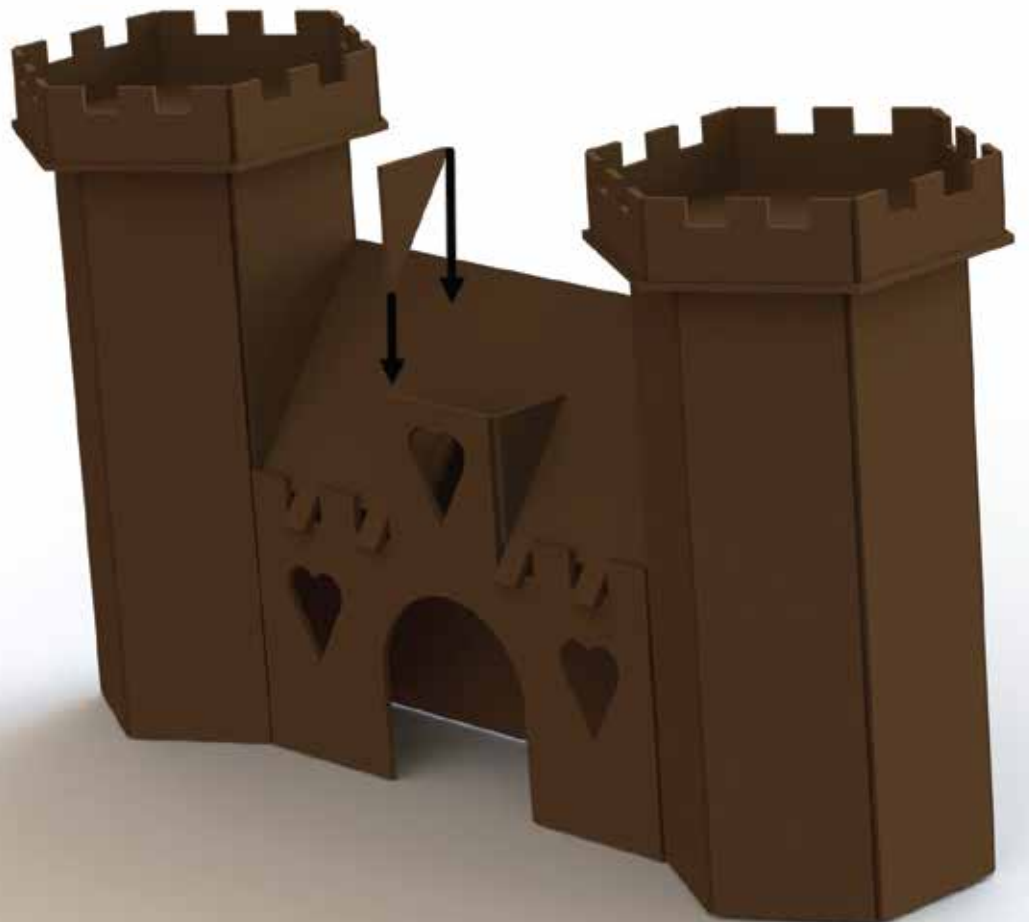

5.

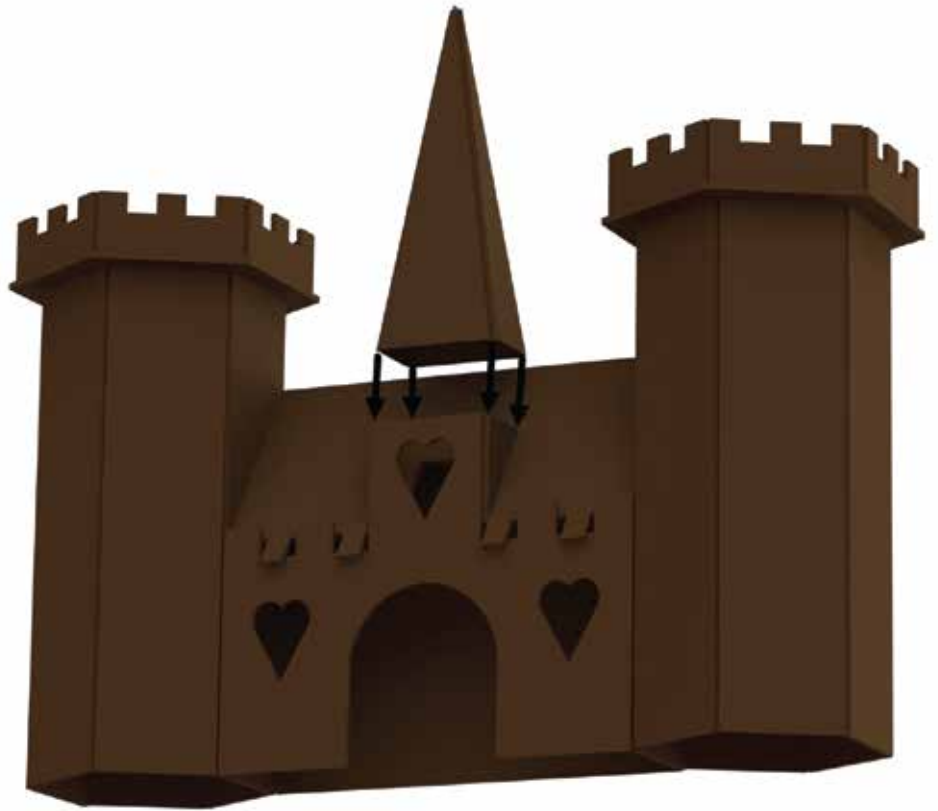
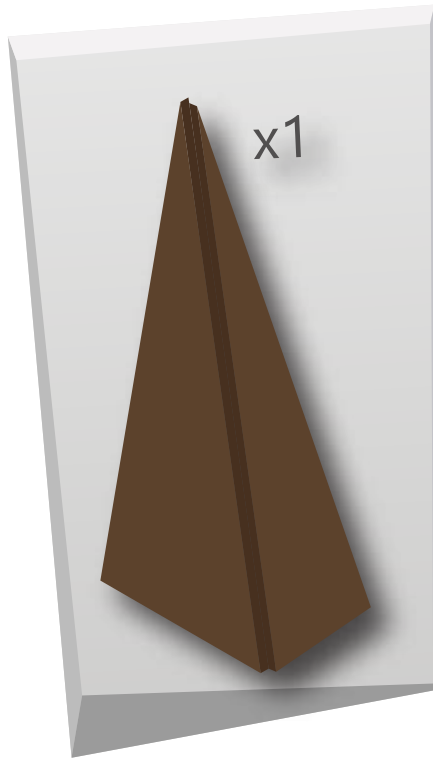

6.



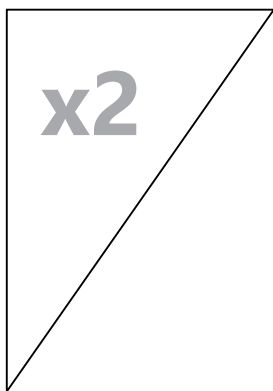

Akende jaoks võid vabalt kasutada ka mõnd piparkoogivormi.

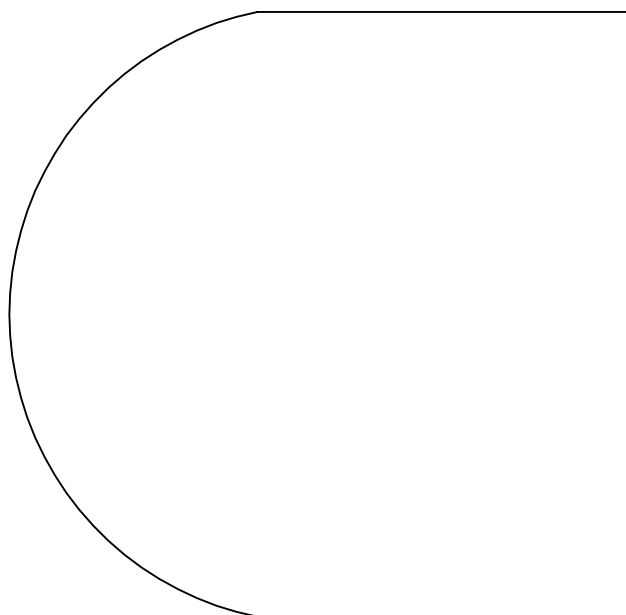
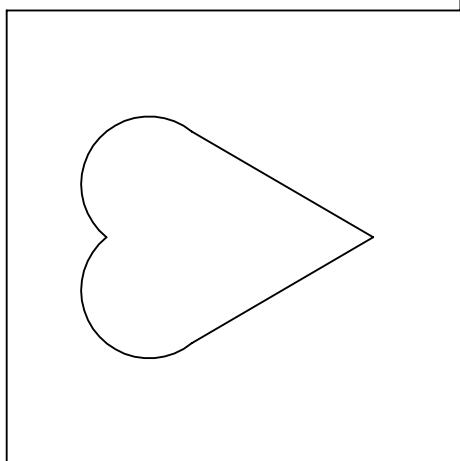
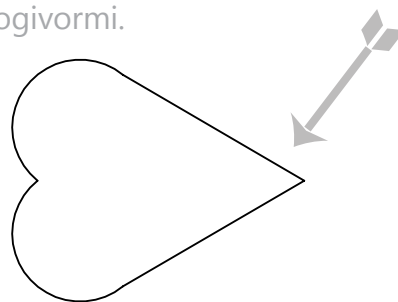

Kui panna aknaaukudesse lutsukomm (enne taigna ahju panekut) peaks saama akendele ka klaasid ette. Ma ise proovinud ei ole, aga jutte olen kuulnud.

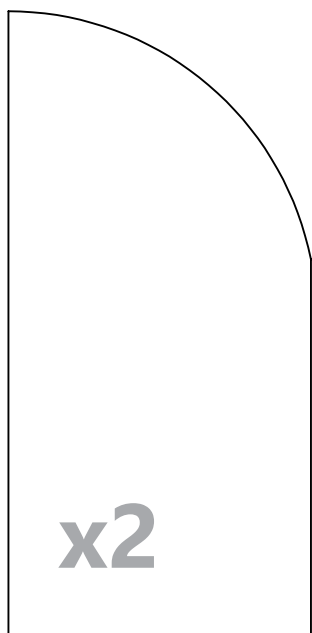
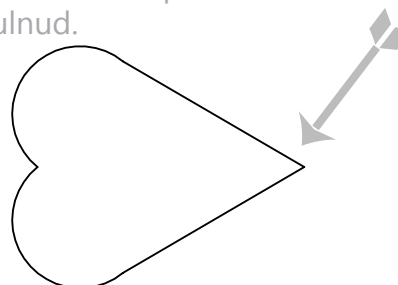

**x1**

x1



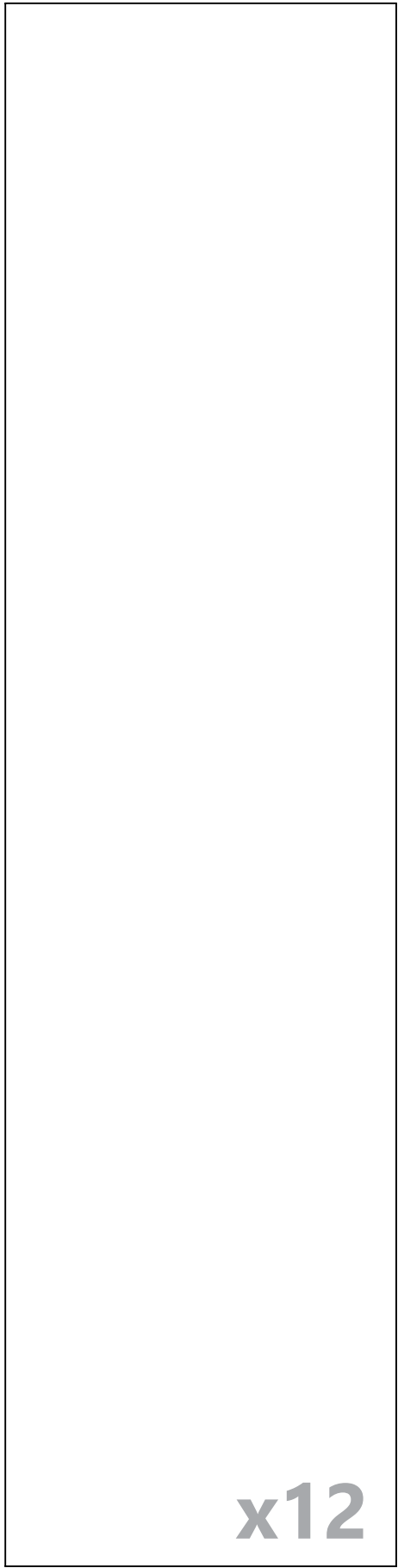

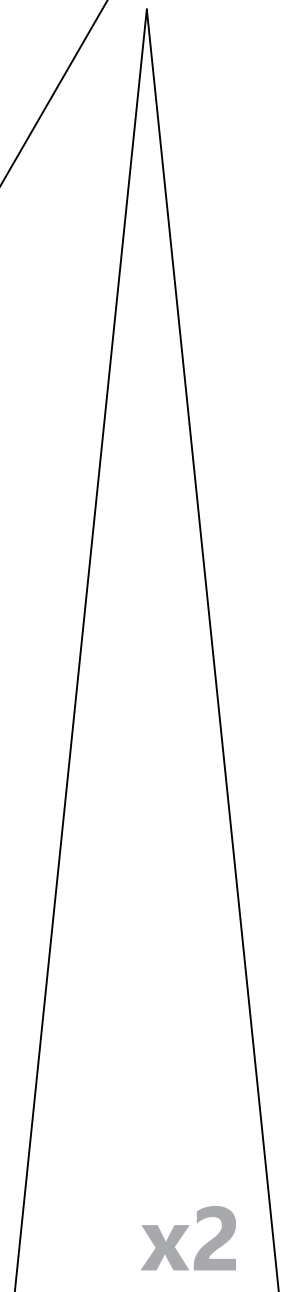
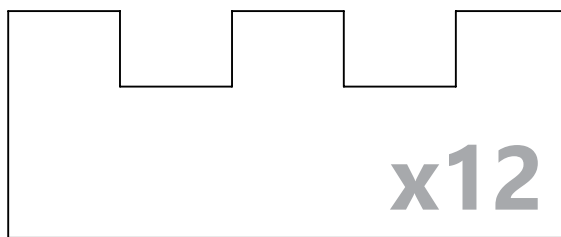
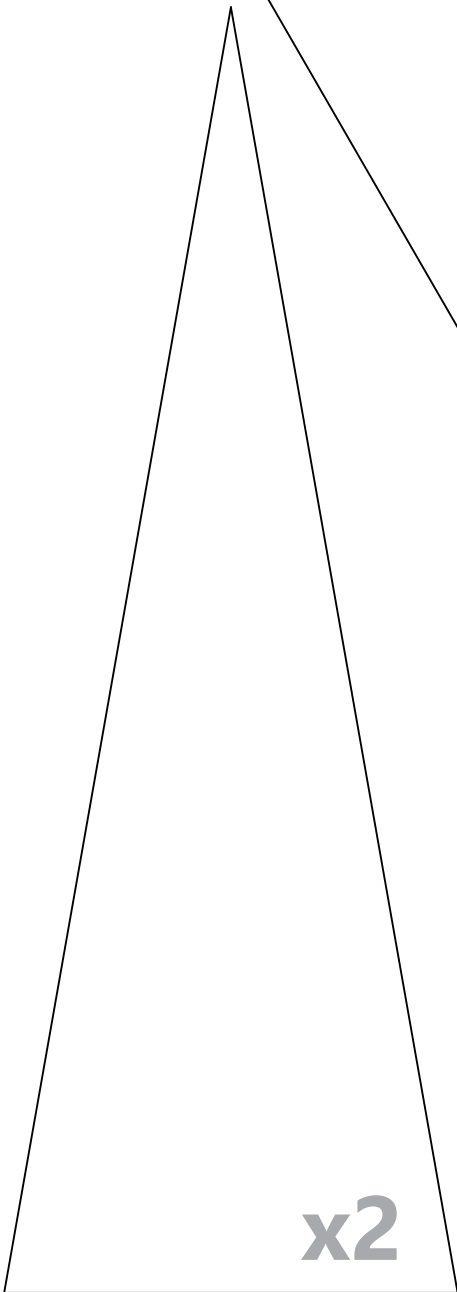
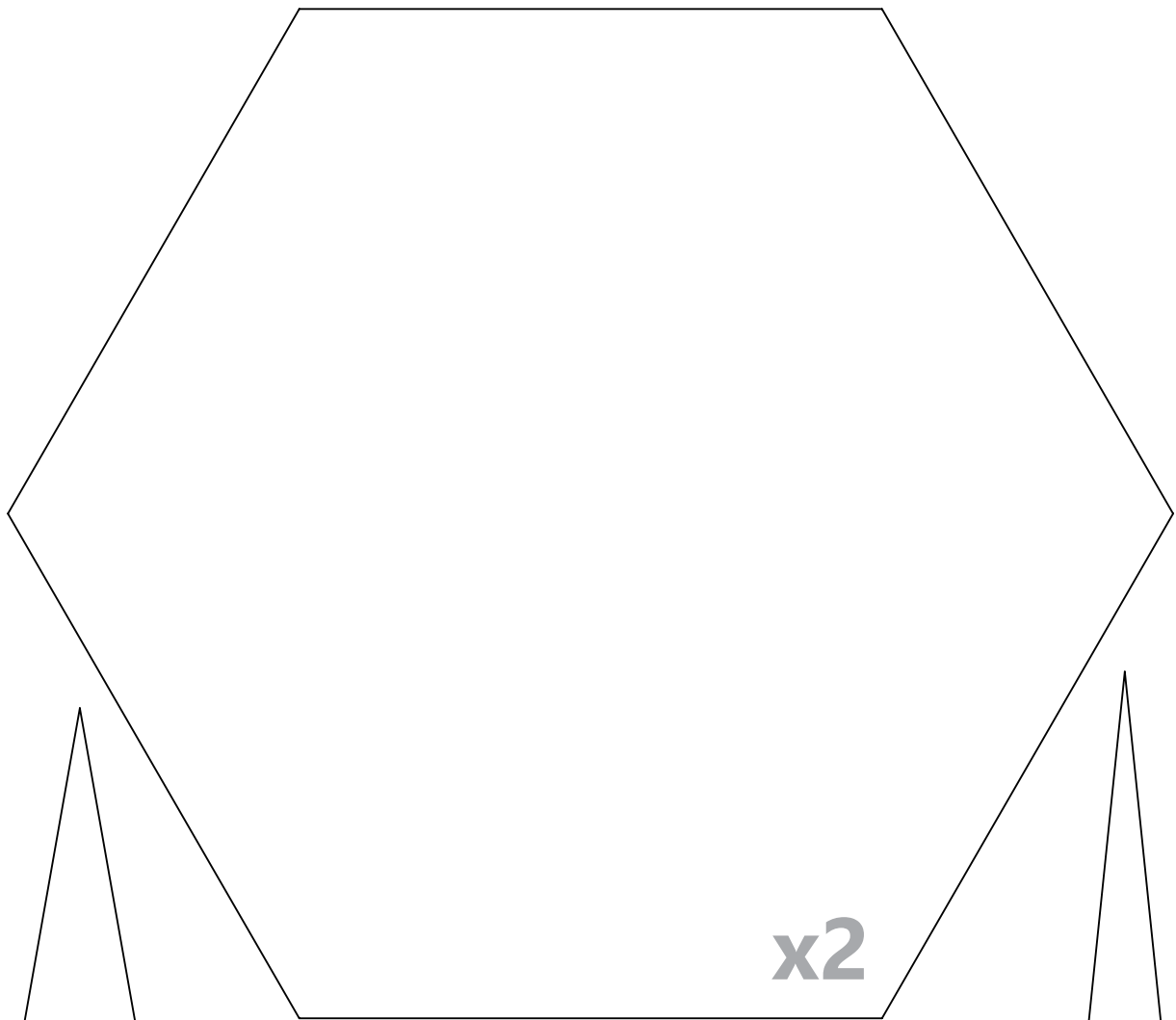

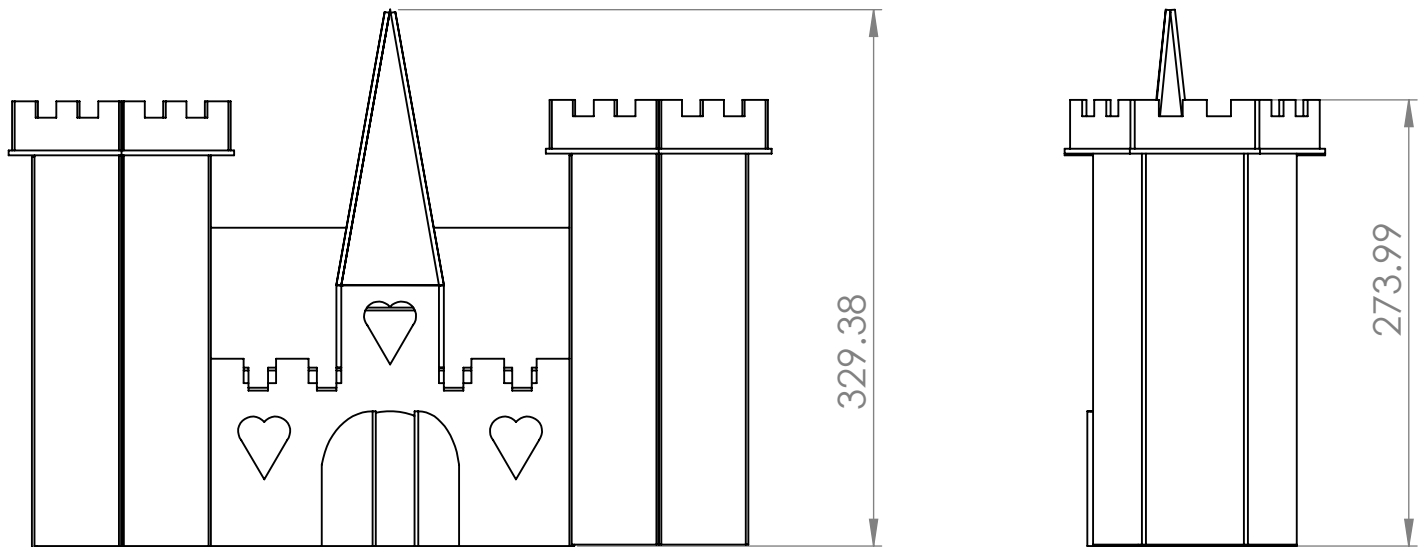
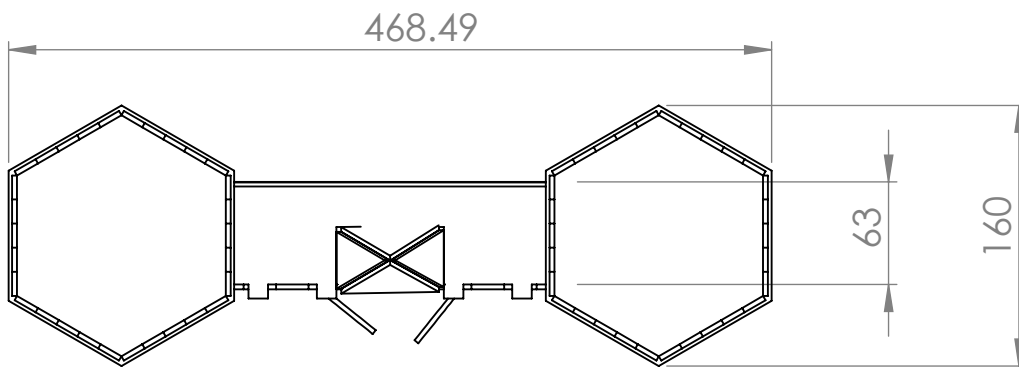

Antud mõõdud (mm) on muidugi umbkaudsed. Tegelikult piparkook paisub ahjus ja ka šabloonide välja lõikamine ei pruugi olla millimeetri pealt täpne. :)

